

PRODUCT FEATURES

- IGBT CHIP(Trench+Field Stop technology)
- High short circuit capability
- $V_{CE(sat)}$ with positive temperature coefficient
- Fast switching and short tail current
- Free wheeling diodes with fast and soft reverse recovery
- Low switching losses



APPLICATIONS

- High frequency switching application
- Medical applications
- Motion/servo control
- UPS systems

IGBT-inverter

ABSOLUTE MAXIMUM RATINGS($T_C=25^\circ\text{C}$ unless otherwise specified)

Symbol	Parameter/Test Conditions		Values	Unit
V_{CES}	Collector Emitter Voltage	$T_J=25^\circ\text{C}$	600	V
V_{GES}	Gate Emitter Voltage		± 20	
I_C	DC Collector Current	$T_C=25^\circ\text{C}, T_{Jmax}=175^\circ\text{C}$	472	A
		$T_C=60^\circ\text{C}, T_{Jmax}=175^\circ\text{C}$	400	
I_{CM}	Repetitive Peak Collector Current	$t_p=1\text{ms}$	800	
P_{tot}	Power Dissipation Per IGBT	$T_C=25^\circ\text{C}, T_{Jmax}=175^\circ\text{C}$	1200	W

Diode-inverter

ABSOLUTE MAXIMUM RATINGS ($T_C=25^\circ\text{C}$ unless otherwise specified)

Symbol	Parameter/Test Conditions		Values	Unit
V_{RRM}	Repetitive Reverse Voltage	$T_J=25^\circ\text{C}$	600	V
$I_{F(AV)}$	Average Forward Current		400	A
I_{FRM}	Repetitive Peak Forward Current	$t_p=1\text{ms}$	800	
I^2t		$T_J=125^\circ\text{C}, t=10\text{ms}, V_R=0\text{V}$	14.1	kA^2s

MacMic Science & Technology Co., Ltd.

Add: #18, Hua Shan Zhong Lu, New District, Changzhou City, Jiangsu Province, P. R. of China

Tel.: +86-519-85163708 Fax: +86-519-85162291 Post Code: 213022 Website: www.macmicst.com

MMG400D060B6TC

IGBT-inverter

ELECTRICAL CHARACTERISTICS ($T_C=25^\circ\text{C}$ unless otherwise specified)

Symbol	Parameter/Test Conditions		Min.	Typ.	Max.	Unit
$V_{GE(th)}$	Gate Emitter Threshold Voltage	$V_{CE}=V_{GE}, I_C=6.4\text{mA}$	5.0	5.8	6.5	V
$V_{CE(sat)}$	Collector Emitter Saturation Voltage	$I_C=400\text{A}, V_{GE}=15\text{V}, T_J=25^\circ\text{C}$		1.55	2.0	
		$I_C=400\text{A}, V_{GE}=15\text{V}, T_J=125^\circ\text{C}$		1.75		
		$I_C=400\text{A}, V_{GE}=15\text{V}, T_J=150^\circ\text{C}$		1.8		
I_{CES}	Collector Leakage Current	$V_{CE}=600\text{V}, V_{GE}=0\text{V}, T_J=25^\circ\text{C}$			1	mA
		$V_{CE}=600\text{V}, V_{GE}=0\text{V}, T_J=150^\circ\text{C}$			5	mA
I_{GES}	Gate Leakage Current	$V_{CE}=0\text{V}, V_{GE}=\pm 15\text{V}, T_J=25^\circ\text{C}$	-400		400	nA
R_{gint}	Integrated Gate Resistor			1		Ω
Q_g	Gate Charge	$V_{CE}=300\text{V}, I_C=400\text{A}, V_{GE}=15\text{V}$		1.88		μC
C_{ies}	Input Capacitance	$V_{CE}=25\text{V}, V_{GE}=0\text{V}, f=1\text{MHz}$		25.2		nF
C_{res}	Reverse Transfer Capacitance				1040	
$t_{d(on)}$	Turn on Delay Time	$V_{CC}=300\text{V}, I_C=400\text{A}$ $R_G=1.5\Omega,$	$T_J=25^\circ\text{C}$		70	ns
			$T_J=150^\circ\text{C}$		90	ns
t_r	Rise Time	$V_{GE}=\pm 15\text{V},$ Inductive Load	$T_J=25^\circ\text{C}$		74	ns
			$T_J=150^\circ\text{C}$		80	ns
$t_{d(off)}$	Turn off Delay Time	$V_{CC}=300\text{V}, I_C=400\text{A}$ $R_G=1.5\Omega,$	$T_J=25^\circ\text{C}$		390	ns
			$T_J=150^\circ\text{C}$		460	ns
t_f	Fall Time	$V_{GE}=\pm 15\text{V},$ Inductive Load	$T_J=25^\circ\text{C}$		60	ns
			$T_J=150^\circ\text{C}$		70	ns
E_{on}	Turn on Energy	$V_{CC}=300\text{V}, I_C=400\text{A}$ $R_G=1.5\Omega,$	$T_J=25^\circ\text{C}$		3.5	mJ
			$T_J=125^\circ\text{C}$		4.6	mJ
			$T_J=150^\circ\text{C}$		5	mJ
E_{off}	Turn off Energy	$V_{GE}=\pm 15\text{V},$ Inductive Load	$T_J=25^\circ\text{C}$		10.7	mJ
			$T_J=125^\circ\text{C}$		12.6	mJ
			$T_J=150^\circ\text{C}$		13.4	mJ
I_{SC}	Short Circuit Current	$tp_{sc}\leq 6\mu\text{s}, V_{GE}=15\text{V}$ $T_J=125^\circ\text{C}, V_{CC}=360\text{V}$		1760		A
R_{thJC}	Junction to Case Thermal Resistance (Per IGBT)				0.125	K /W

Diode-inverter

ELECTRICAL CHARACTERISTICS ($T_C=25^\circ\text{C}$ unless otherwise specified)

Symbol	Parameter/Test Conditions		Min.	Typ.	Max.	Unit
V_F	Forward Voltage	$I_F=400\text{A}, V_{GE}=0\text{V}, T_J=25^\circ\text{C}$		1.7	2.1	V
		$I_F=400\text{A}, V_{GE}=0\text{V}, T_J=125^\circ\text{C}$		1.55		
		$I_F=400\text{A}, V_{GE}=0\text{V}, T_J=150^\circ\text{C}$		1.45		
t_{rr}	Reverse Recovery Time	$I_F=400\text{A}, V_R=300\text{V}$ $di_F/dt=-5000\text{A}/\mu\text{s}$ $T_J=150^\circ\text{C}$		180		ns
I_{RRM}	Max. Reverse Recovery Current			298		A
Q_{RR}	Reverse Recovery Charge			38		μC
E_{rec}	Reverse Recovery Energy			8.5		mJ
R_{thJCD}	Junction to Case Thermal Resistance (Per Diode)				0.22	K /W

MMG400D060B6TC

MODULE CHARACTERISTICS ($T_c=25^\circ\text{C}$ unless otherwise specified)

Symbol	Parameter/Test Conditions		Values	Unit
T_{Jmax}	Max. Junction Temperature		175	°C
T_{Jop}	Operating Temperature		-40~150	
T_{stg}	Storage Temperature		-40~125	
V_{isol}	Isolation Breakdown Voltage	AC, 50Hz(R.M.S), t=1minute	3000	V
CTI	Comparative Tracking Index		> 225	
Torque	to heatsink	Recommended (M6)	3~5	Nm
	to terminal	Recommended (M6)	2.5~5	Nm
Weight			300	g

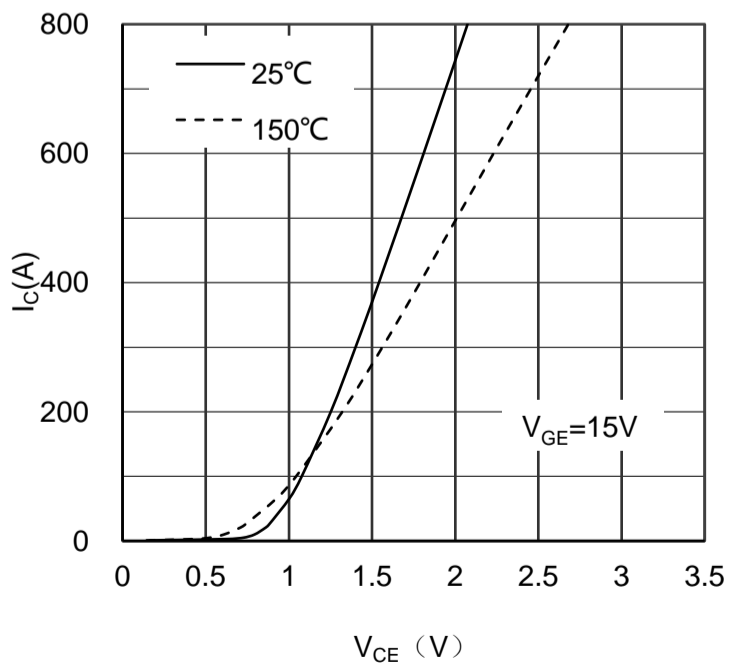

Figure 1. Typical Output Characteristics IGBT-inverter

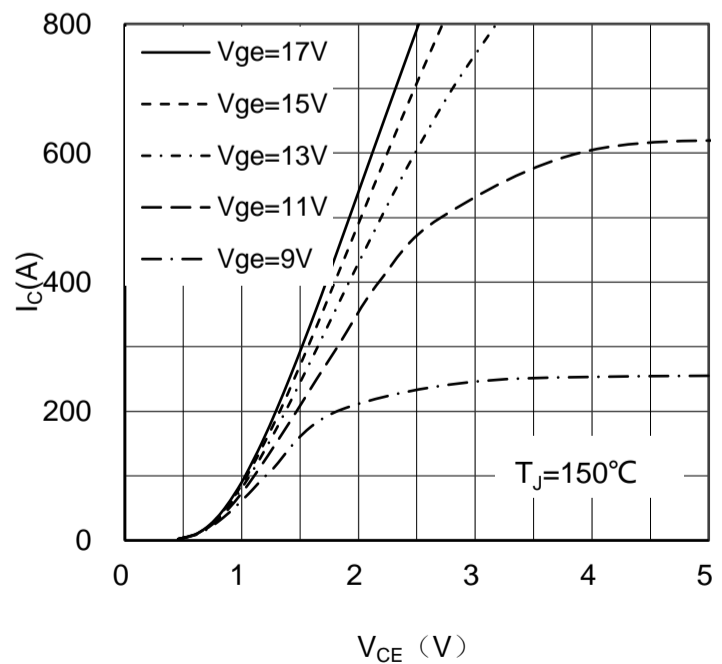

Figure 2. Typical Output Characteristics IGBT-inverter

MMG400D060B6TC

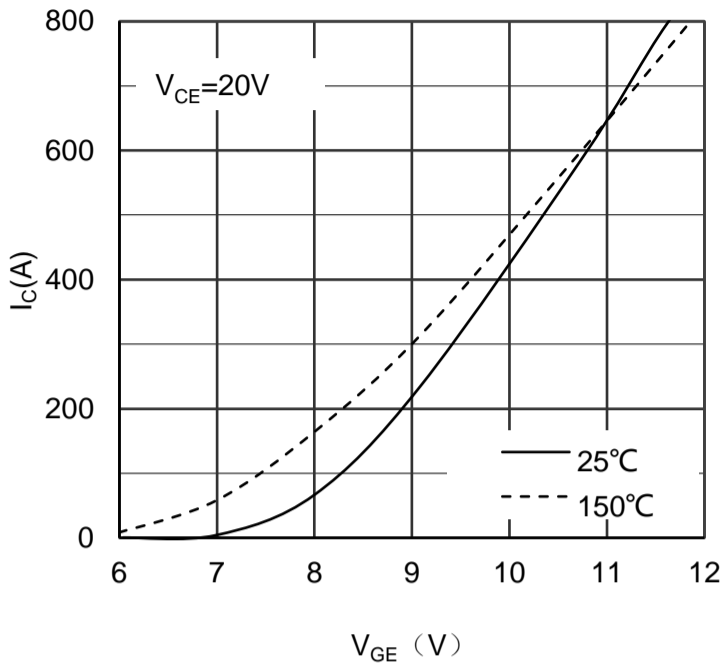

Figure 3. Typical Transfer characteristics IGBT-inverter

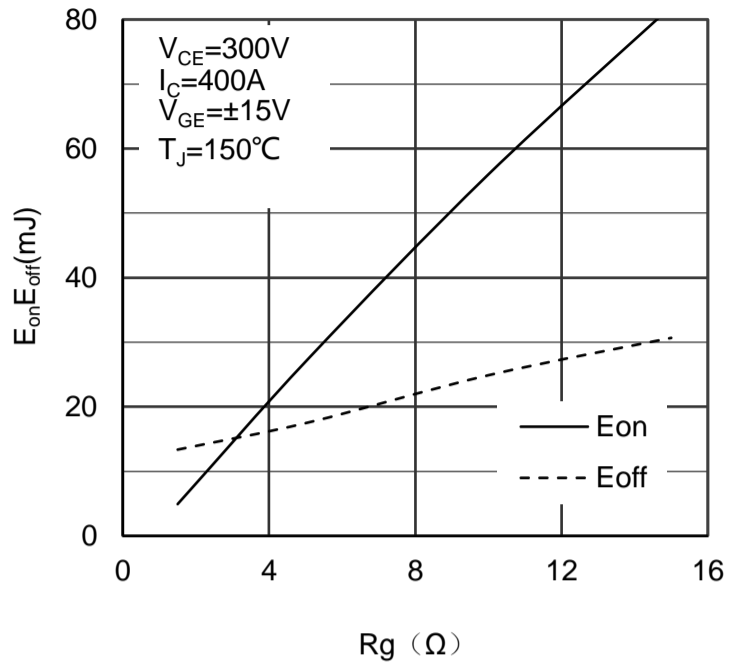

Figure 4. Switching Energy vs Gate Resistor IGBT-inverter

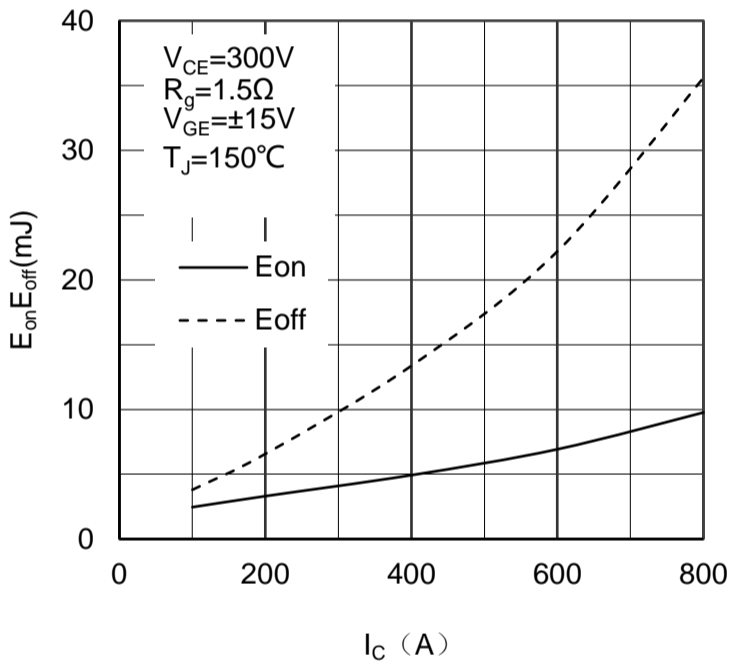

Figure 5. Switching Energy vs Collector Current IGBT-inverter

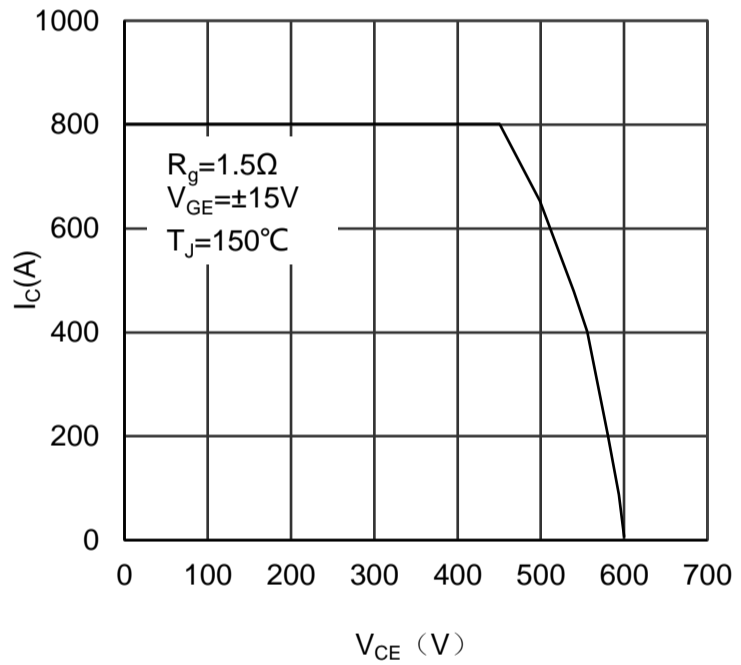

Figure 6. Reverse Bias Safe Operating Area IGBT-inverter

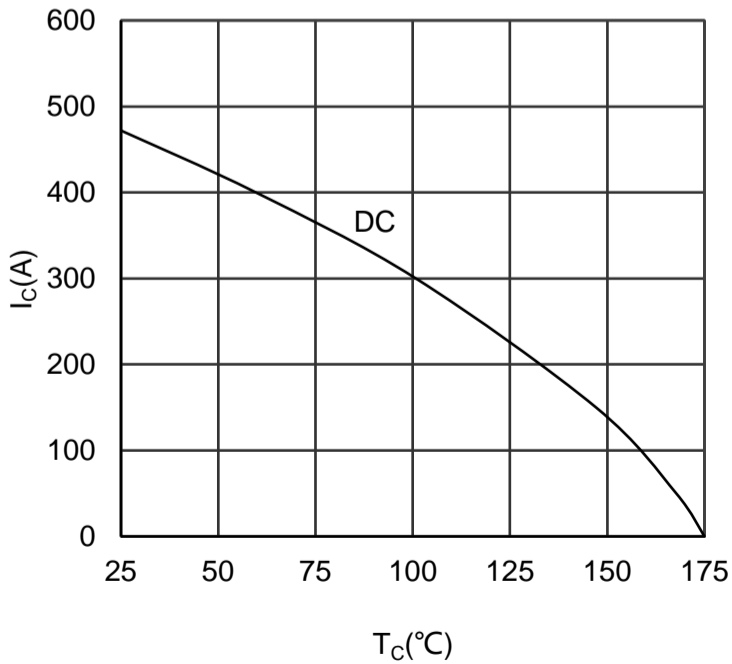

Figure 7. Collector Current vs Case temperature IGBT-inverter

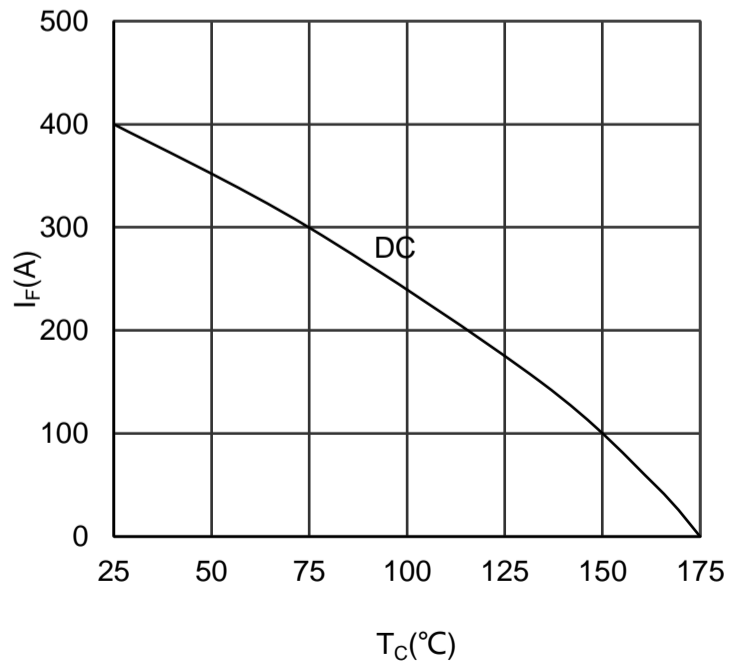

Figure 8. Forward current vs Case temperature Diode-inverter

MMG400D060B6TC

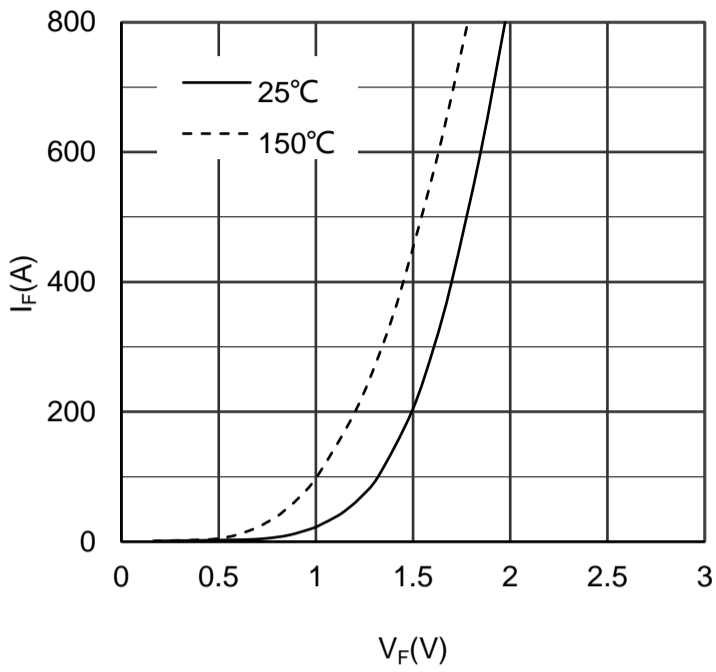

Figure 9. Diode Forward Characteristics Diode -inverter

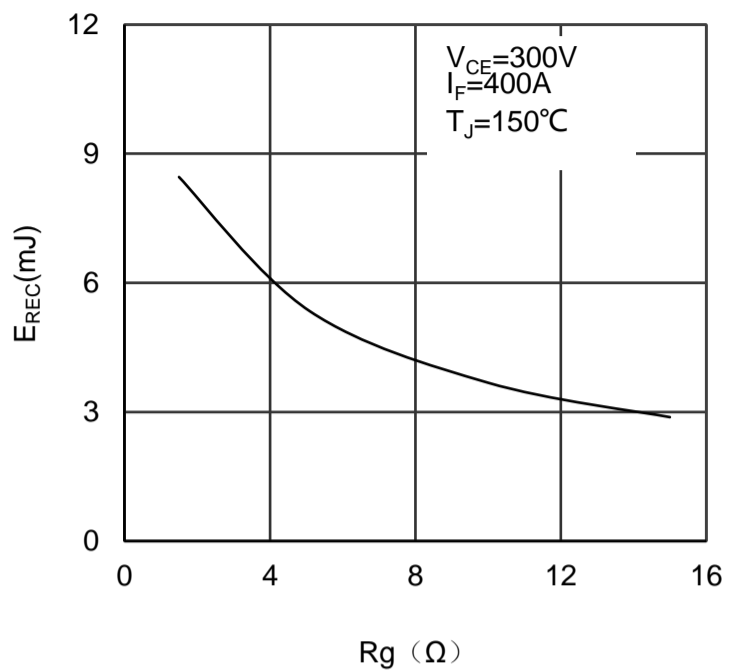

Figure 10. Switching Energy vs Gate Resistor Diode -inverter

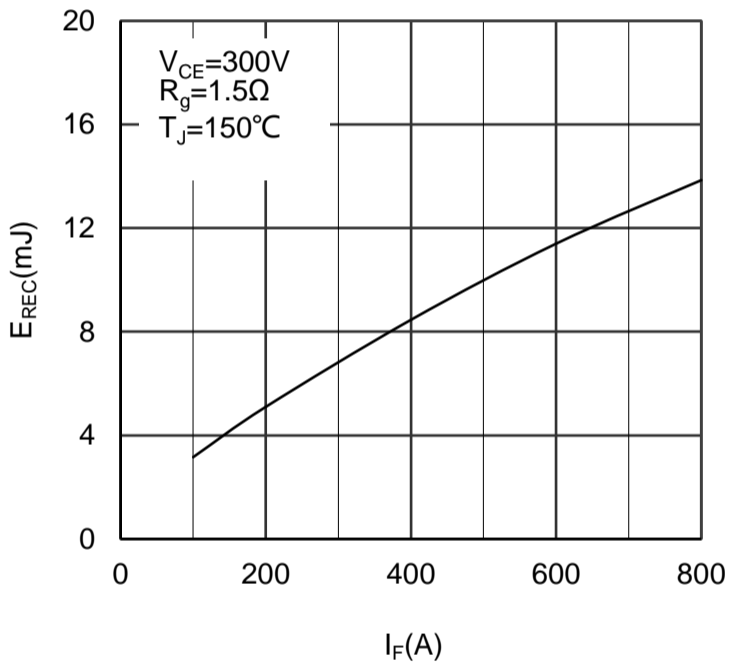

Figure 11. Switching Energy vs Forward Current Diode-inverter

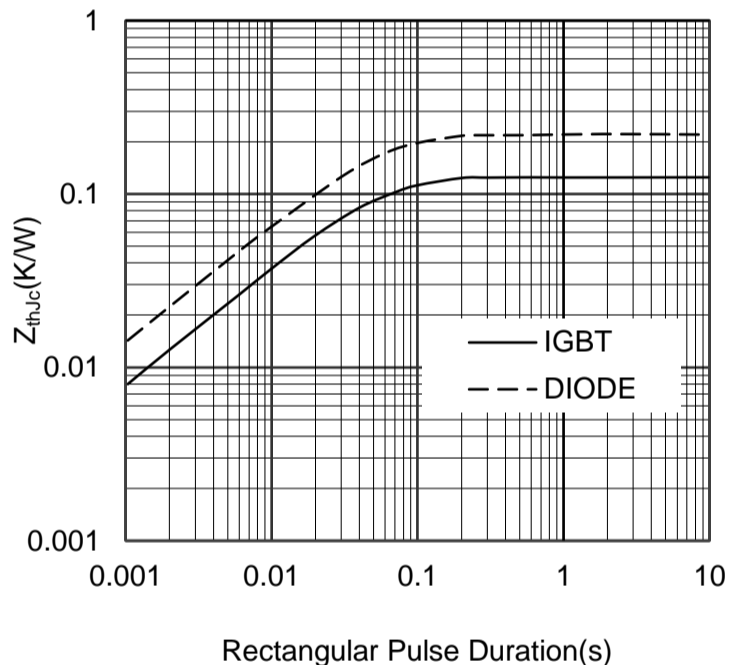

Figure 12. Transient Thermal Impedance of Diode and IGBT-inverter

MMG400D060B6TC

061

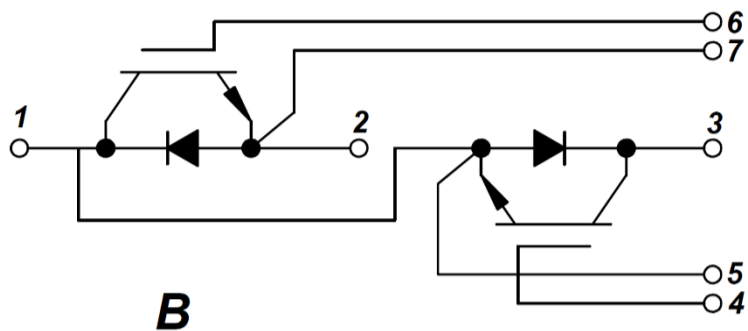
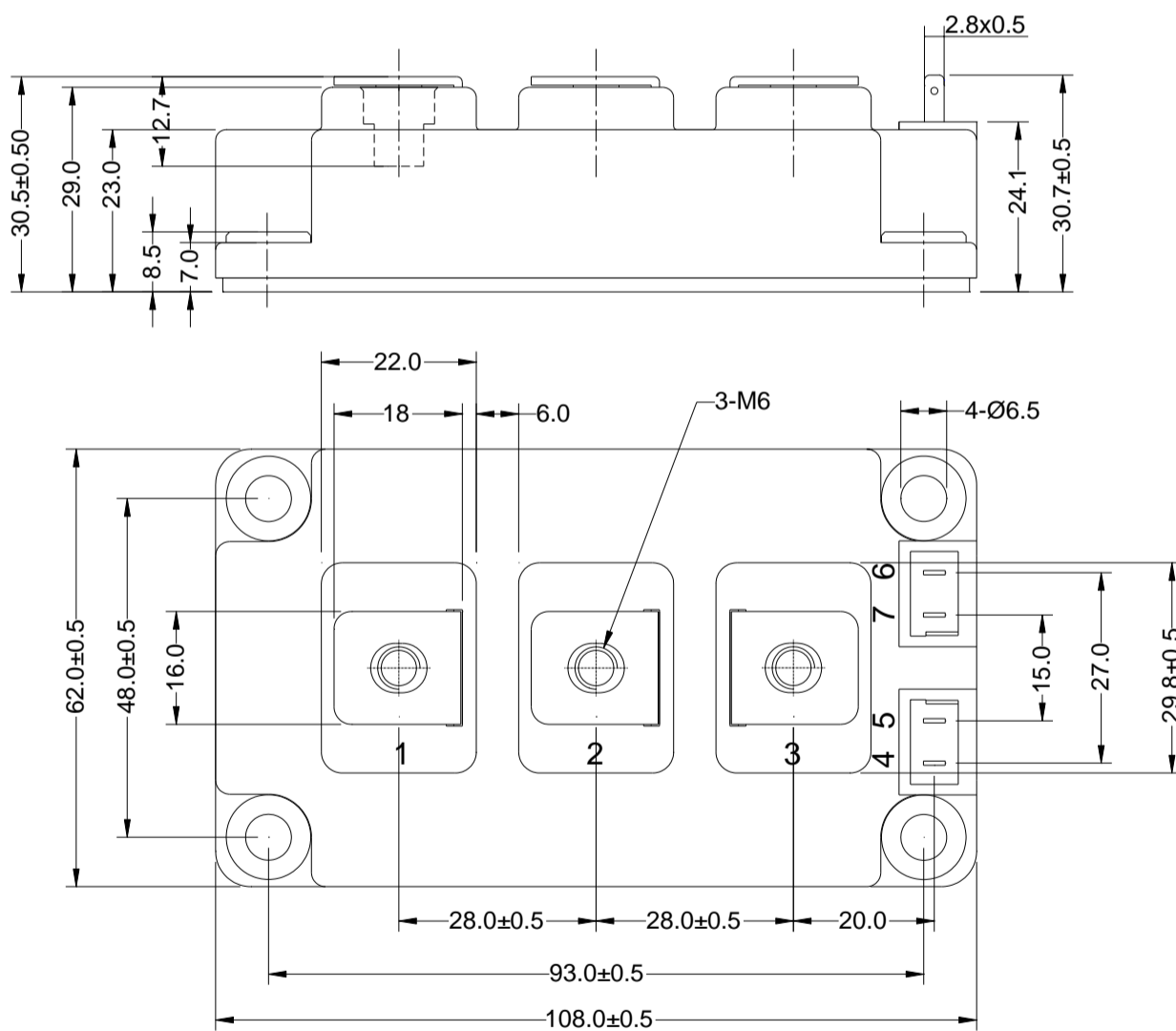

Figure 13. Circuit Diagram



Dimensions in (mm)
Figure 14. Package Outline